

Model of Agricultural Sprayer Installation and Nozzle Operation

Fanel Dorel Scheaua

The cultivation of agricultural land represents an important field of interest for all countries because through this area basic food is provided for human communities. Agricultural machines are considered part of special mechanical equipments category intended to perform mechanized works in farmlands, in order to obtain the optimal harvests. This paper shows a functional description of sprayer installation model which can be attached to the agricultural tractors. It represents an auxiliary installation capable of preparing the fluid mixtures to achieve the application of different sanitary treatments (herbicides, fungicides, insecticides) on field crops, using the hydraulic system of the agricultural tractor to which is connecting. The mounting solution for the installation is at the rear side of the tractor being the model widely used on most constructive pattern of agricultural tractors. Also a CFD analysis it was conducted on two nozzle models that can be used for treatment application on crops in agricultural fields. The results are presented for each nozzle model highlighting the fluid velocity substance coverage and total pressure for each model.

Keywords: *agricultural machine, sprayer installation, computational fluid dynamics*

1. Introduction

Agriculture represents a key domain of each country's economy as it provides the basic food for their population.

In the current context of rising demand for basic foods is needed more than ever of an increase of agricultural production, based on the appropriate use of farm lands.

In order to obtain optimal harvests is required an adequate level of endowment with efficient agricultural equipment capable of performing mechanical soil working in a short time with reduced fuel consumption.

There are different equipments that can be attached to the agricultural tractor in order to perform field works as plowing, sowing, applying of fertilizers on the land or sanitary treatments on plants.

Such agricultural equipment used to apply fluid treatments over culture plants is described in this paper.

It is an installation that can be attached to the rear side of the agricultural tractor and represent an economical solution for applying various treatments on agricultural crops.

There are some specialized and autonomous installations for treatments application on field plants but they represent a more expensive solution for farmers.

Thus, for small farms equipments are required to be used attached to the tractor in order to accomplish different job tasks for the plants cultivation process in an economically and efficient manner.

2. Model of Agricultural Sprayer Installation

The installations intended for application of different treatments on field plants are specialized equipments that can be both attached or towed by the agricultural tractor, but also can be self propelled in case of high capacity installations.

Such equipments operates based on the forced circulation and spraying mixtures of fluids specifically designed to help the development of field plants without being affected by pests after treatments application.

Thus, the installations attached to the tractor are connected to his power source in order to achieve the circulation of its working fluid.

A functional scheme for the sprayer installation is shown in Figure 1.

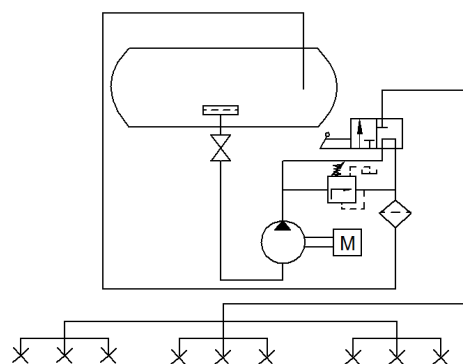

Figure 1. Schematic representation of sprayer installation components

A three-dimensional model for the sprayer installation that can be attachable to the agricultural tractor equipment was built using Solid Edge software shown in figure 2.

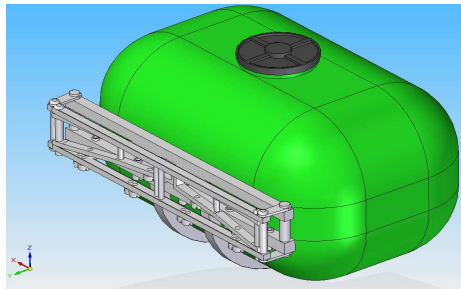
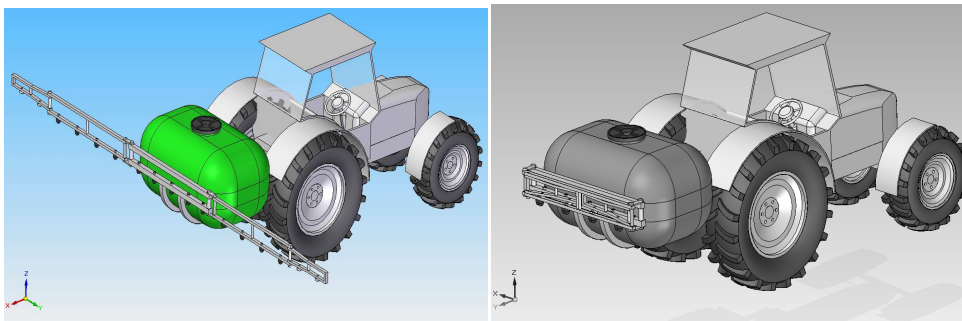

Figure 2. Sprayer installation assembly model [1]

The three-dimensional assembly model of the tractor with sprayer installation mounted is presented in figure 3, for both working position and for the transport position.



a) The working position for sprayer installation

b) The transport position for sprayer installation

Figure 3. Schematic representation for tractor with sprayer installation mounted [1]

3. Nozzle Operation Analysis

The special installations for treatments applications are used to manage field crops, vineyards or horticultural crops, in order to combat pests and diseases and use chemicals in the form of fluidic or powder solutions.

The working process is carried out by spreading on the plants by spraying the substances mixture in form of very fine droplets or powders.

The machines intended for applying treatments on field plants must be able to achieve high productivity to enable work execution in a short time and with minimum fuel consumption of the base machine.

To achieve the proposed job tasks, the installation makes the substances mixture within its own tank, forming in this way the working fluid, which is sprayed in the external environment in the immediate proximity of the plants in order to achieve the best possible coverage.

The working fluid entrainment and circulation from the tank to the nozzle valves for spraying is carried out using a source of pressurized air.

The sprayer installation comprises a spray pump for driving the working fluid, piping and jet nozzles through which fluid flows dispersed to achieve a good coverage on the surface.

The pump provides both external spraying but also the permanent fluid mixture inside the reservoir.

The most widely used pump types for the agricultural spraying installations are centrifugal, roller, or piston pumps.

The working parameters of the sprayer installation like fluid flow rate and pressure can be determined according to the nozzle type used, fluid volume sprayed per surface unit and the tractor forward speed in the working front.

Two three-dimensional models for the nozzle valve were realized using Solid Edge software. The two nozzle models have particular constructive solutions regarding the geometric shape and number of outlets for the working fluid spraying. Thus, the two models have one to four fluid outlets.

For each model numerical analysis was performed using ANSYS CFX software.

In the initial conditions have been declared two fluids, one being the liquid mixture and the other compressed air by means of which the liquid is entrained from the reservoir. The working fluid has a maximum speed of 50 m/s at the outlet and a droplet size of 50 microns.

The results are presented below for each model, showing working fluids circulation velocity through nozzle to the external environment and total pressure values.

In figure 4 are presented the nozzle valve models.



a) model 1
(two orifices)

b) model 2
(four orifices)

Figure 4. Three-dimensional nozzle models for sprayer installation

The obtained results for nozzle model 1 (case 1) regarding fluid velocity and total pressure are presented in figure 5.

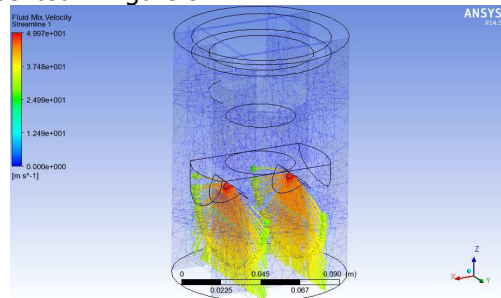

a) fluid mixture velocity values

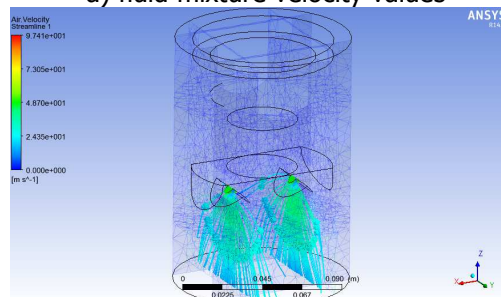

b) air velocity values

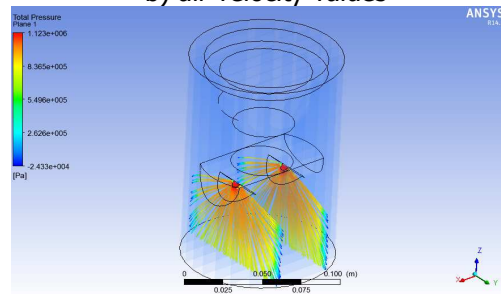

c) Total pressure values

Figure 5. The obtained results for nozzle valve (model 1)

The obtained results for nozzle model 2 (case 2) are presented in figure 6, in terms of fluid values and total pressure.

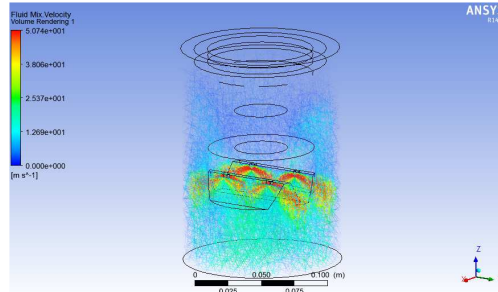

a) water velocity values

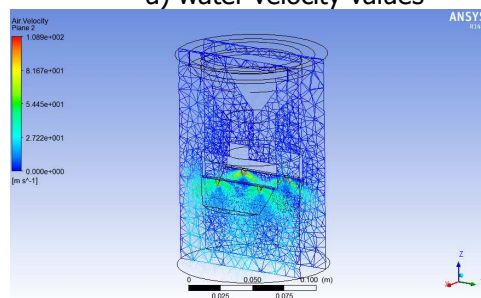

b) air velocity values

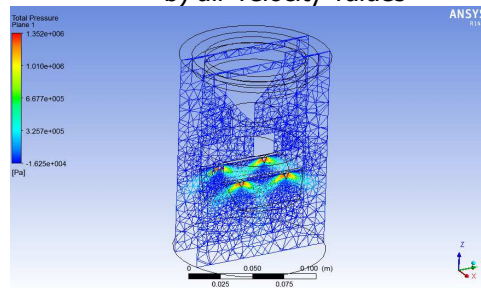

c) Total pressure values

Figure 6. The obtained results for nozzle valve (model 2)

The numerical results recorded on the two nozzle models (case 1 and case 2) are shown in table 1.

Table 1. The numerical obtained results for the analyzed cases

Case 1		
Fluid mix velocity [m/s]	Air velocity [m/s]	Total pressure [bar]
12,49	24,35	2,626
24,99	48,7	5,496
37,48	73,05	8,365
49,97	97,41	11,23

Case 2		
Fluid mix velocity [m/s]	Air velocity [m/s]	Total pressure [bar]
12,69	27,22	3,257
25,37	54,45	6,677
38,06	81,67	10,1
50,74	108,9	13,52

For the values obtained in the two cases for velocity and total pressure graphic representation was made as shown in figure 7.

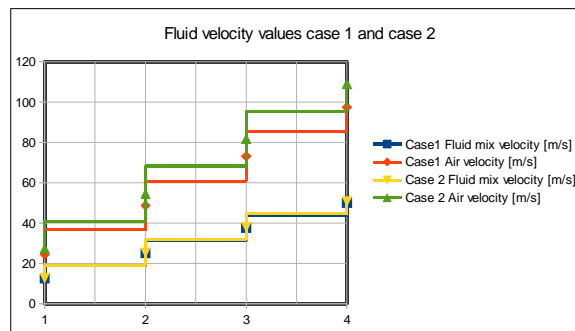

a) Fluids velocity values

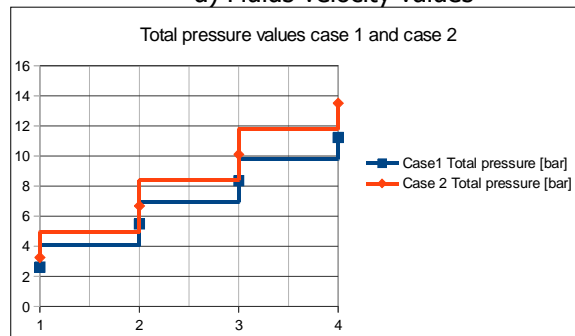

b) Total pressure values

Figure 7. Graphic representation of the experimental values obtained (case 1 and case 2)

4. Conclusion

A sprayer installation model that can be attached to the rear side of the agricultural tractor was described in this paper. Also two nozzle models that can be used for spraying the working fluid was designed and analyzed regarding the operation principle.

The obtained values show that total pressure is at higher value for case 2.

The values obtained for the fluids velocity show higher values for air velocity for both cases.

The liquid mixture velocity values are considered to be comparable for both analyzed cases.

The sprayer installations attachable to agricultural tractor are intended for crop plants treatment applications, helping in this way the efficiency increase in agriculture and achieving optimum harvests onto cultivated land.

References

- [1] Șcheaua F., *Sprayer installation attached to the agricultural tractor*, JIDEG Magazine, Volume 10, Issue 1, 2015.
- [2] Șcheaua F., *Model of hydraulic suspension mechanism for agricultural tractor*, JIDEG Magazine, ISSN 2344-4681, Volume 9, Issue No. 1, 2014.
- [3] Șcheaua F., Axinti G., *Seismic protection of structures using hydraulic damper devices*, The annals of Dunarea de Jos University, Vol II, 2010.
- [4] Vasilache L., *Influence of the three-point linkage on the wheel tractor dynamics*, 2012, available at: <https://www.tractoragricol/mecanismdesuspendare>
- [5] Șcheaua F., Nedelcut F., *Energy dissipation device using fluid dampers*, The Annals of "Dunarea de Jos" University of Galati, Fascicle XIV Mechanical Engineering Volume 2 Issue XX, Galați, 2012.
- [6] Fodor A.N., *Cercetări privind optimizarea mentenanței tractoarelor agricole*, 2011.
- [7] Dobre P., *Tractoare și mașini horticoale*, 2009, available at: <https://www.horticultura-bucuresti.ro>
- [8] <https://www.virginiatech>

Address:

- Teaching assistant, PhD Eng. Fanel Dorel Scheaua, "Dunarea de Jos" University of Galati, Domneasca street no. 47, 800008, Galati, fanel.scheaua@ugal.ro