



George Mihalache, Gheorghe Livint, Vasile Horga

## A New Method for Modeling and Control of Hybrid Stepper Motors

Over time the mathematical models of the hybrid stepper motors (HSM) have been developed in various forms. In this paper we propose to use for HSM a model of a two-phase synchronous machine with permanent magnet in which the number of pole pairs is equal to the number of rotor teeth of the HSM. It analyzes the behavior of hybrid stepper motor controlled in open loop. Control signals are obtained by implementing the control sequences: one-phase-on, two-phases-on, half step.

**Keywords:** hybrid stepper motor, mathematical model, one-phase-on, two-phases-on, half step

### 1. Introduction

Lately, positioning systems have been developed and rapidly spread worldwide. In conventional positioning systems electric DC motors were used. Currently these motors were replaced (almost all) with stepper motors. The advantages of stepper motors are: high torque developed at low speed, execution starts, stops and reversals of direction of travel at high speeds without loss of steps [1]-[5].

The construction of these motors is very similar to that of synchronous machines. The phases stator windings are placed on the salient pole. On periphery of the pole pieces are provided evenly distribute teeth. The rotor is made differently depending on the design of stepper motor: stepper motors with variable reluctance, stepper motor with permanent magnet and hybrid stepper motor. In the positioning applications hybrid stepping motors with two phases are used [1]-[6].

Generally, stepper motors are driven by digital electrical pulse train. Every digital electrical pulse applied to the motor performs a well-defined angular displacement of the rotor. Angular displacement depends on both the construction and the control mode of stepper motor. The pulses train commands a control

driver that generates sequences of power signals applied motor phases. HSM is controlled in the following supply sequence: a single-phase-on, two-phase-on, half-step and microsteps mode. Motor control can be made easily using microcontrollers and low cost logic circuits [1-5].

## 2. The mathematical model of the HSM

To establish the mathematical model of stepper motor some simplifying assumptions that do not significantly affect the results are admitted [1], [7]:

- Magnetic permeability of the magnetic circuit is considered infinite;
- Losses in the air gap are neglected;
- Leakage of the magnetic field is neglected;
- Air gap is considered smooth, rotor and stator teeth are neglected.

The number of pole pairs was equal to the number of rotor teeth since the teeth forming the magnetic poles, which are uniformly distributed. From those described above, results that HSM can be considered as a biphasic permanent magnet synchronous machine (PMSM). [2-4]. For HSM can determine two types of models, in the form of a two-phase PMSM [7]:

- The model of primitive machine that uses one a reference system for measurements of the rotor and a reference system for measurements of the stator.
- The model of general machine where both stator and rotor are relative to a single reference system.

The mathematical model of stepper motor consists of equations of the phase voltages of the stator and rotor and the torques equilibrium equation at the motor shaft [7].

The proposed mathematical model of the HSM in rotor reference system is described by the following equations [7]:

$$\begin{bmatrix} u_{SD}^r \\ u_{SQ}^r \end{bmatrix} = \begin{bmatrix} R_s & 0 \\ 0 & R_s \end{bmatrix} \begin{bmatrix} i_{SD}^r \\ i_{SQ}^r \end{bmatrix} + \frac{d}{dt} \begin{bmatrix} \psi_{SD}^r \\ \psi_{SQ}^r \end{bmatrix} + \omega_R \begin{bmatrix} 0 & -1 \\ 1 & 0 \end{bmatrix} \begin{bmatrix} \psi_{SD}^r \\ \psi_{SQ}^r \end{bmatrix} \quad (1)$$

$$\begin{bmatrix} \psi_{SD}^r \\ \psi_{SQ}^r \end{bmatrix} = \begin{bmatrix} L_s & 0 \\ 0 & L_s \end{bmatrix} \begin{bmatrix} i_{SD}^r \\ i_{SQ}^r \end{bmatrix} + \psi_M \begin{bmatrix} 1 \\ 0 \end{bmatrix} \quad (2)$$

$$M_e = P(\psi_{SD}^r i_{SQ}^r - \psi_{SQ}^r i_{SD}^r) \quad (3)$$

where:  $R_s$  and  $L_s$  are respectively the resistance and inductance of the stator phase,  $P$  – number of rotor teeth,  $M_e$  – electromagnetic torque is, and  $\psi_M$  - the permanent magnet flux and:



### 3. Pulse generator for One-Phase-On sequence

The way of implementation in Matlab-Simulink supply sequence on a phase (One-Phase-On) is described in [1]. Power phases in sequence One-Phase-On is made sequentially with alternative voltage pulse trains. This sequence is performed using combinational logic circuits. The sequence of feed phases is B +, A-, B-, A +. Currently, these sequences are generated using microcontrollers / microprocessors [1].

To find the minimal logic function, one use the truth table shown in Table 1. The first column of the table represents the sequence control signal. Also, the first signal may control the speed of the motor [1], [8].

Table 1.

T	B	C	Phase
1	1	1	B+
0	1	1	
1	0	1	A-
0	0	1	
1	1	0	B-
0	1	0	
1	0	0	A+
0	0	0	

From the above table the Boolean equations for one-phase-on sequence are determined. The implementation of these functions in Matlab-Simulink is presented in Figure 2.

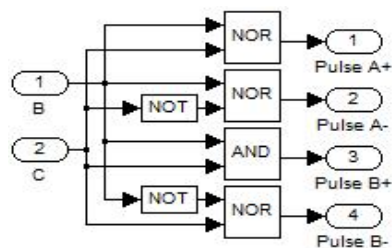

Figure 2. Simplified functions of control sequence one-phase-on.

The control signals of drivers that supply motor phases are illustrated in Figure 3. In each transition from low to high we can be see that one obtains pulse sequences controlling two H-Bridge. Significance of signs + and - is that the command pulses of H-Bridge supply motor phase with positive or negative polarity voltage.

#### 4. Pulse generator for Two-Phase-On sequence

The two-phase-on control sequence requires simultaneous and sequentially supply of two phases. In this case, the motor absorbs a higher electrical power and develops a greater electromagnetic torque. Command pulses of both H-Bridges are determined based on the truth table presented in Table 2.

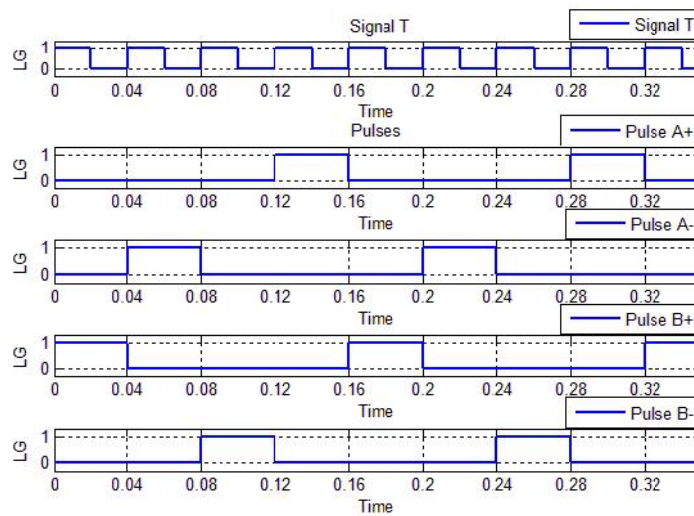

Figure 3. Control signals with 35Hz frequency for the one-phase-on sequence.

Table 2.

T	B	C	Phases
1	1	1	A+B+
0	1	1	
1	0	1	B+A-
0	0	1	
1	1	0	A-B-
0	1	0	
1	0	0	B-A+
0	0	0	

As in the previous case, logic functions are determined based on the truth table shown in Table 2, and are implemented with logical diagram presented in

Figure 4. One can see a significant reduction of logic operators. The control signals for drivers that supply motor phases are presented in Figure 5. It can be seen that for each transition of signal T from low to high pulse sequences controlling two H-bridges to power two phases simultaneously are obtained.

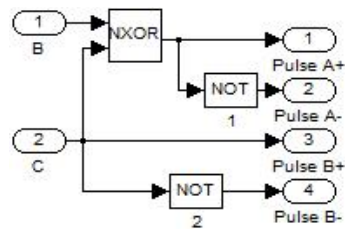

Figure 4. Logical diagram for two-phase-on sequence.

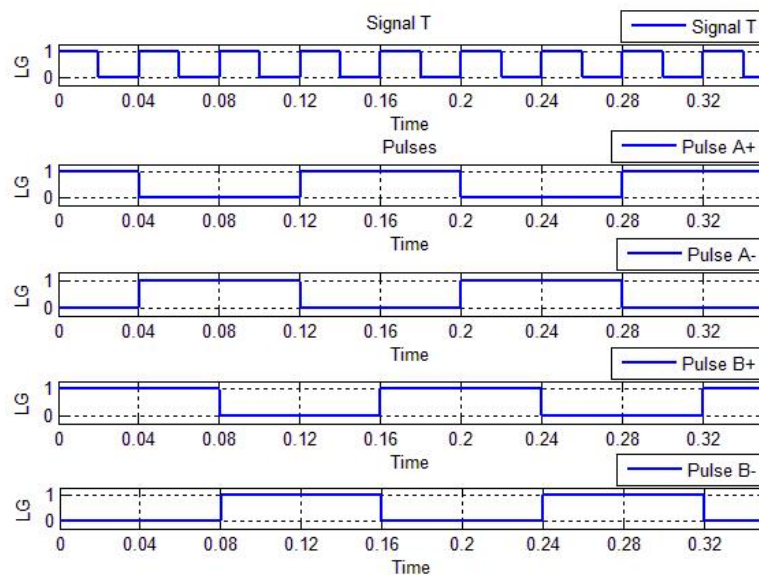

Figure 5. Control signals with 35Hz frequency for the two-phase-on sequence.

### 5. Pulse generator for half step sequence

The half step sequence combines the two methods described above. More specifically, the phases are alternately and supplied sequentially. In this case, the energy absorbed by the motor depends on the number of phases supplied.

In order to determine the control signals to the H-Bridge drivers is done as in previous cases. In this case, the truth table is shown in Table 3 and in Figure 6 is represented its corresponding logical diagram.

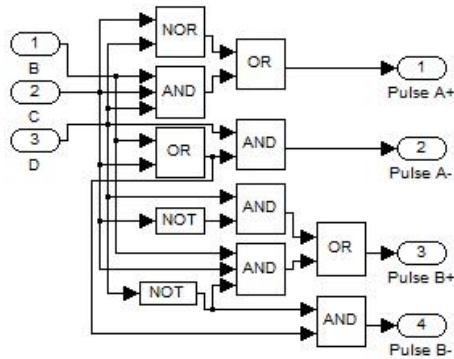

Figure 6. The logical diagram for half step sequence.

Table 3.

T	B	C	D	Phases
1	1	1	1	A+B+
0	1	1	1	
1	0	1	1	B+
0	0	1	1	
1	1	0	1	A-B+
0	1	0	1	
1	0	0	1	A-
0	0	0	1	
1	1	1	0	A-B-
0	1	1	0	
1	0	1	0	B-
0	0	1	0	
1	1	0	0	B-A+
0	1	0	0	
1	0	0	0	A+
0	0	0	0	

Control signals for half step sequence obtained by simulation are presented in Figure 7.

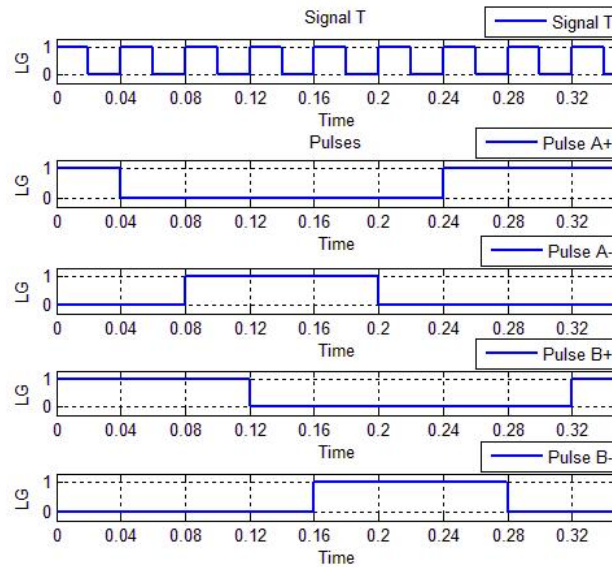

Figure 7. Control signals for half step sequence.

## 6. Simulation results

To validate the mathematical model (described by equations (1-4)), we use a HSM with the following parameters [1], [5]:  $L_a = L_b = 12\text{mH}$ ,  $R_a = R_b = 11$ ,  $D = 0.025\text{Nm /rad /s}$ ,  $P = 50$ ,  $J = 1.125 * 4.10 \text{ kgm}^2$ ,  $M = 0.0044\text{Wb}$ , step angle of 1.8 degrees. The study of the behavior of motor for control sequences described above was performed in Matlab-Simulink simulation. The experiments were carried out with a pulse train with a frequency of 25 Hz for command motor. To supply the phase two H-Bridge in Matlab-Simulink was implemented.

In the first case, for the sequence one-phase-on control, the voltages and currents in the motor phases are shown in Figure 8.

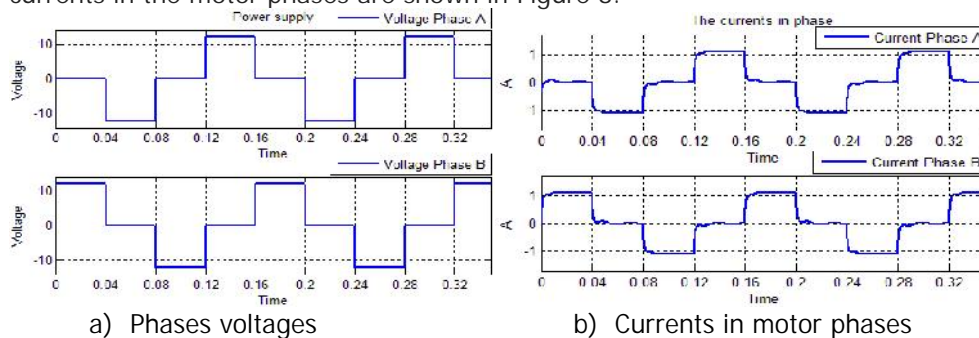

Figure 8. The voltages and currents in the motor phases.



In Figure 8 one can be observed that the phases are supplied sequentially with alternative pulse trains; Voltages and currents have similar types of variation. HSM controlled in this way develops a variable torque depending on the rotor position; This can be seen in Figure 9.a. In Figure 9.b one can be observed angular displacement of the motor which is performed on each control pulse.

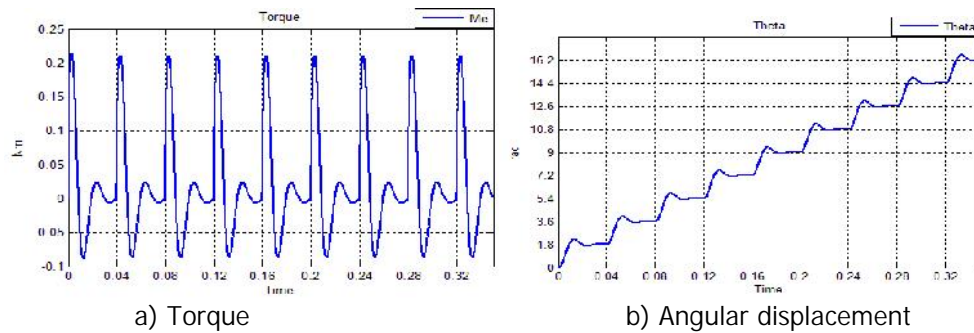

Figure 9. Developed torque and angular displacement.

In the control sequence two-phases-on the phase voltages are rectangular with alternating polarity (Figure 10.a). Current waveforms are similar to the voltage and are shown in Figure 10.b.

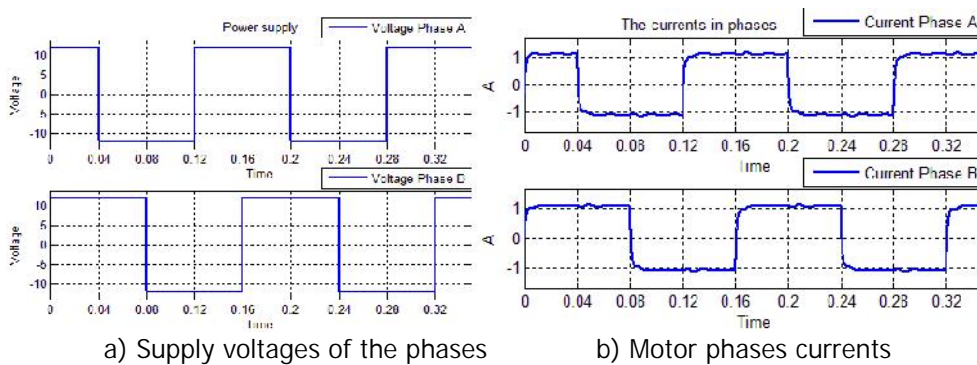

Figure 10. Forms of the voltages and of the currents in the motor phases.

The motor develops a higher electromagnetic torque than the previous sequence, because both phases are supplied at the same time, and absorbs much more electrical power. This is presented in Figure 11.a. The first angular displacement is performed at half step, after which displacements are made with whole step (Figure 11.b).

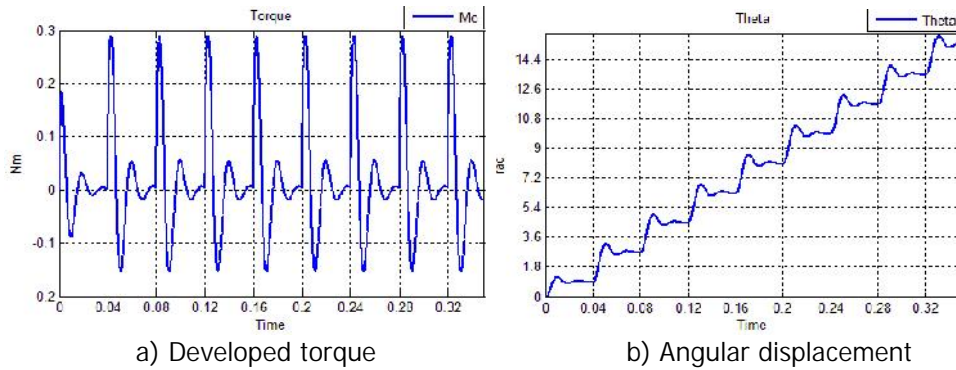

Figure 11. The developed torque and angular displacement.

So far we have seen that in both sequences described above the motor made the displacements with whole step at every impulse control. In this case the motor resolution in this case is determined by its geometrical construction. Doubling the resolution can be achieved by combining the two control methods described above. The number of phases powered simultaneously is dependent on the rotor position. The phase voltages are also similar to those in Figure 8a, except that the voltage pulse is three times longer (Figure 12.a). The form and period of the current in phase are similar to the phase voltage (Figure 12.b).

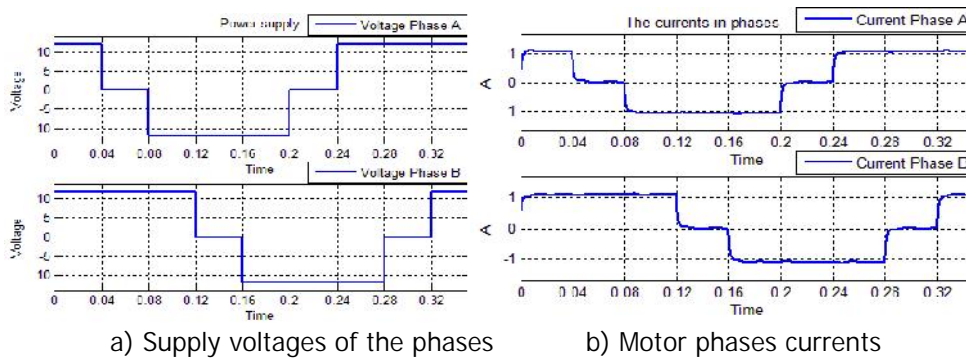

Figure 12. The forms of the voltages and the currents in the motor phases.

The torque developed by the motor has different values at each step executed by the motor. The torque has high value when simultaneously powered two phases are and a low value when just one phase is energized (figure 13a.). In this case, the step motor is cut in half to thereby doubling the resolution of the motor (figure 13 b).

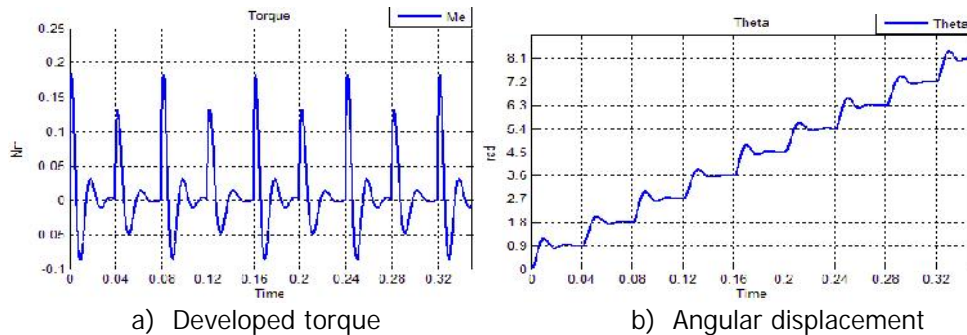

Figure 13. The developed torque and angular displacement.

#### 4. Conclusion

The above simulation results confirm the property of stepper motor to turn a pulse train in incremental movements precisely defined. Also, motor resolution is not conditioned by internal construction of HSM.

The results show that the HSM can be modeled using the equations (1-6). So the model of a two-phase permanent magnet synchronous machine can be used to model a hybrid stepper motor in which the number of pole pairs is equal to the number of rotor teeth of the HSM. Vector control method for permanent magnet synchronous machine can be used to control hybrid stepper motor.

In the next paper we present experimental results which will validate the results obtained by simulation.

#### References

- [1] Mihalache G. Zbant (Adam) A., Livint G., Open-Loop Control of Hybrid Stepper Motor with Two Phases Using Voltage to Frequency Converter, 8<sup>th</sup> International Symposium on Advanced Topics in Electrical Engineering (ATEE), IEEE Catalog Number CFP1314P-CDR.
- [2] Acarnley P., Stepping Motors – A guide to theory and practice, 4<sup>th</sup> Edition, The Institution of Electrical Engineering of Technology, 2002, London.
- [3] Takashi K., Stepping motors and their microprocessor controls, Monographs in electrical and electronic engineering, Oxford 1984.
- [4] John. C., Modeling and High-Performance Control of Electrical Machine. The Institute of Electrical and Electronics Engineers, Inc., 2005, New York ,591-645 (IEEE Press series on power engineering).
- [5] Morar A., Comanda inteligenta a acțiun rilor electrice cu motoare pas cu pas, Editura Mediamira, Cluj Napoca, 2007.

- [6] Elksasy M.S.M., Hesham H.G., A New Technique for Controlling Hybrid Stepper Motor Through Modified PID Controller, International Journal of Electrical & Computer Sciences IJECS-IJENS, Vol. 10, No.02, April, 2010, 28-35.
- [7] Ratoi M.C., Doctoal Thesis, Contribuții la perfecționarea comenzii sistemelor de acționare electric cu motoare de curent alternativ, Electrical Engineering, Energetics and Applied Informatics Faculty, Gheorghe Asachi Technical University, 2010, 95-97.
- [8] Nicula D., Electronica Digitala. Carte de invatatura., Editura Universitatii Transilvania, Brasov, 2012.

Addresses:

- PhD. Student Eng. George Mihalache, "Gheorghe Asachi" Technical University of Iasi, Bd. Prof. Dr. doc. Dimitrie Mangeron, nr. 67, 700050, Iasi, [george.eth09@gmail.com](mailto:george.eth09@gmail.com)
- Prof. PhD. Eng. Gheorghe Livint, "Gheorghe Asachi" Technical University of Iasi, Bd. Prof. Dr. doc. Dimitrie Mangeron, nr. 67, 700050, Iasi, [glivint@tuiasi.com](mailto:glivint@tuiasi.com)
- Assoc. Prof. PhD. Eng. Vasile Horga, "Gheorghe Asachi" Technical University of Iasi, Bd. Prof. Dr. doc. Dimitrie Mangeron, nr. 67, 700050, Iasi, [horga@tuiasi.com](mailto:horga@tuiasi.com)